

HZ-HD03

User Manual



V1.0



Reading Tips

This manual applies to the UAV radio countermeasure equipment developed and produced by the company. The manual provides comprehensive specifications, functional design, structure and specification requirements of the system, as well as installation, deployment, and operational requirements, serving as an operational guide for end users.

Symbol Legend

	Supplementary Notes: Additional explanations and annotations to the main text of the manual.
	Safety Notices: Important operational warnings and risk prevention guidelines for users.
	DANGER: Indicates imminent hazards which, if not avoided, will result in death or serious injury and major property damage.

Manual Usage Recommendations

1. Before using the product, please read this manual thoroughly. Retain this manual for future reference to address any operational inquiries.
2. All photographs, graphics, charts, and illustrations in this manual are for explanatory purposes only and may differ from the actual product. Refer to the physical product for exact specifications. The company reserves the right to update this manual due to product version upgrades or other requirements, with the latest electronic version to be distributed to users.
3. The company recommends using this manual under the guidance of qualified personnel.

Safety Notice

Before using the product, please carefully read the following precautions and operate the product correctly as required.

Installation Precautions

Environmental Requirements

Do not install or store the product in any of the following locations:

- Extreme environments: places where temperatures exceed the range of -25°C to 60°C or where frost may form.
- Near strong electromagnetic interference sources or equipment with large current fluctuations.
- Areas with flammable, explosive, corrosive gases or dust.
- Damp or water-exposed areas. Liquid ingress may cause electric shock or fire hazards.

Operational Guidelines

- Only qualified personnel or designated maintenance staff may open the chassis.
- All antennas must be fully connected and tightened according to the labels. Powering on the device without antennas installed is strictly prohibited.

Usage Precautions

Power and Electrical Safety

- Use only the specified AC 110 V–220 V power supply.
- Do not pull or bend the power cord. Avoid crushing or twisting it, and stop using it if damaged.
- Do not operate the equipment during thunderstorms. Avoid touching power lines or device connectors during lightning to prevent electric shock.
- Always unplug the power cord before moving the device.
- Do not touch the power plug with wet hands.

- When unplugging the power cord, hold the plug body firmly.

Operational Risk Warnings

- If abnormal conditions such as smoke, unusual noises, or burning smells occur, shut off power immediately and contact our after-sales service department.
- Do not install any software unrelated to the software platform; system issues caused by such software are not covered under warranty.
- Do not connect unauthorized USB drives or external hard drives to avoid malware infection. Do not delete server files arbitrarily, change the system time, or shut down or restart the server without authorization.
- Unauthorized personnel are prohibited from disassembling the device to avoid damaging internal components or compromising your rights. If the device malfunctions during use, contact our after-sales service department.

Regulatory Compliance

- This device may cause radio interference during operation. Users must take feasible measures to mitigate such interference.
- If suspected interference occurs with civil-aviation or military frequencies, stop using the device immediately, investigate the cause, and report the incident.

Table of Contents

READING TIPS	I
Symbol Legend	I
Manual Usage Recommendations	I
SAFETY NOTICE	II
Installation Precautions	II
Usage Precautions	II
1 PRODUCT INTRODUCTION	3
1.1 Main Functions	3
1.2 Product Appearance	4
1.3 Ports and Buttons	5
1.4 Mechanical Characteristics	6
2 EQUIPMENT DEPLOYMENT PREPARATION	7
2.1 Site Selection	7
2.2 Delivery Checklist	8
3 DEPLOY THE EQUIPMENT	9
3.1 Connect Antennas	9
3.2 Power On / Power Off	10
3.3 Connect to the Network	10
3.4 Install Micro SD Card	12
3.5 Charge	13
4 DRONE DEFENSE SYSTEM	14
4.1 Passive Detection	16
4.2 Event Function Area	19
4.3 Device Status	25

4.4	Cloud Services	35
4.5	Settings	35
5	EQUIPMENT MAINTENANCE	41
5.1	Routine Maintenance	41
5.2	Basic Troubleshooting	41
6	PACKAGING, TRANSPORTATION AND STORAGE	43
6.1	Packaging	43
6.2	Transportation	43
6.3	Storage	43

1 Product Introduction

This product is H3 Pro, a single-soldier handheld, high-precision integrated detection and positioning system. Equipped with a built-in low-altitude drone defense system, it enables drone detection, trajectory tracking, and remote controller (pilot) positioning. Additionally, it supports real-time analysis and monitoring of First-Person View (FPV) drone live feeds.

1.1 Main Functions

Compact and Portable

Light in weight and small in size. Portable, shockproof and drop-proof.

Trajectory Tracking

Multi-target trajectory tracking, and pilot (remote control) tracking. This function is available for the drones can be decoded.

Precise Identification

Precisely identify the serial number, model, position, speed, altitude, trajectory, and remote controller information of the drones.

Analog Video Transmission

The system can provide live FPV steam of detection, identification, and real-time video transmission.

1.2 Product Appearance

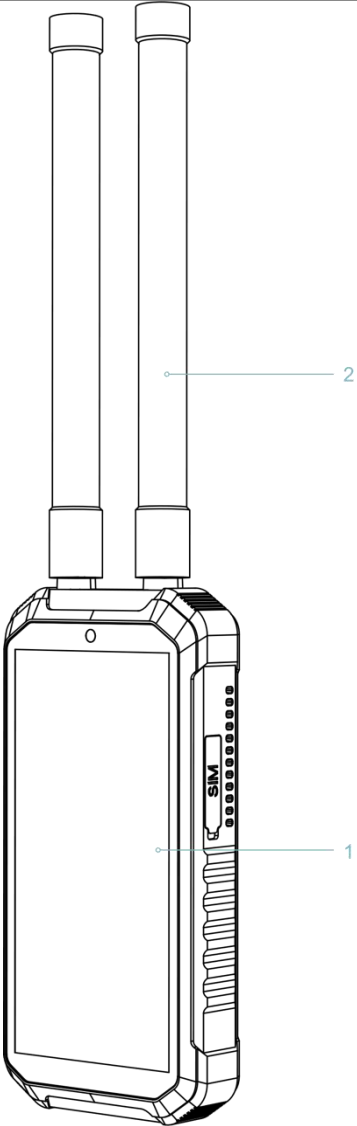

1. Main unit

2. Antennas

1.3 Ports and Buttons

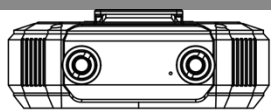

Top View

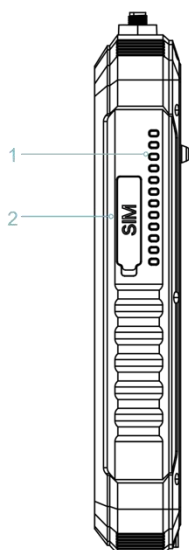

Right View

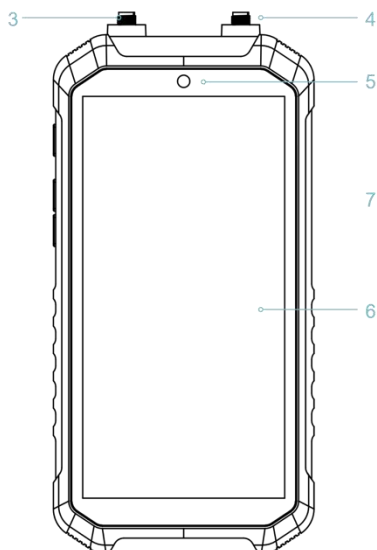

Front View

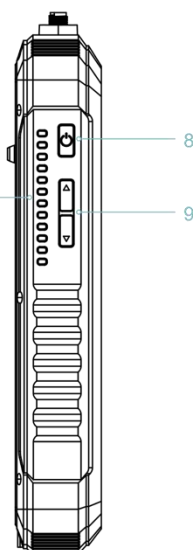

Left View

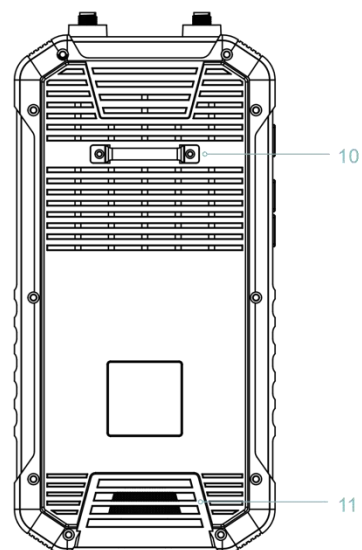

Back View

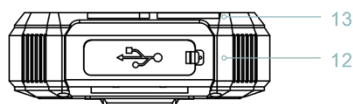

Bottom View

- 1. Ventilation Holes
- 2. SIM Card Slot
- 3. WiFi Detection Antenna Port
- 4. Full-band Detection Antenna Port
- 5. Front Camera
- 6. Touch Screen
- 7. Ventilation Holes
- 8. Power On/Off Button
- 9. Volume Keys
- 10. Wristband Mount
- 11. Speaker
- 12. Type-C Port & 3.5mm Audio Jack
- 13. Wristband Slot

1.4 Mechanical Characteristics

Item	Specification
Size⁽¹⁾	
Length	177mm
Width	89mm
Height	30mm
Screen Size	
Screen Size	6.0 Inch
Weight	
Weight	580g

(1) The data are of the main unit, exclude fiberglass antenna.

2 Equipment Deployment Preparation

This device adopts a portable design ideal for rapid outdoor deployment. Under compliant environmental conditions, it ensures stable operation and optimal detection performance. First check the specifications and quantity of all parts and standard parts according to the equipment delivery list, and then assemble them step by step according to the following installation steps.





2.1 Site Selection

The equipment is typically deployed outdoors. Site the equipment should pay attention to the following factors:

- Visibility environment:** Choose a flat, open highland or building rooftop, ensuring a 360° unobstructed view for the antenna placement.
- Electromagnetic environment:** Avoid electromagnetic interference zones such as microwave stations, radio transmission towers, and high-voltage power line crossings, as well as areas near glass curtain wall clusters and large metal structures (e.g., bridges, transmission towers).
- Natural environment:**
- Avoid the wind to reduce the equipment antenna wind load.
 - When deploying in thunderstorm-prone areas, avoid locations susceptible to water accumulation and lightning strikes.
- Electrical Environment:** Avoid areas near electrified railways, base stations, or any other sources prone to signal interference.
- Infrastructure:** Ensure the site has mains power access and supports connection to public or dedicated communication networks.

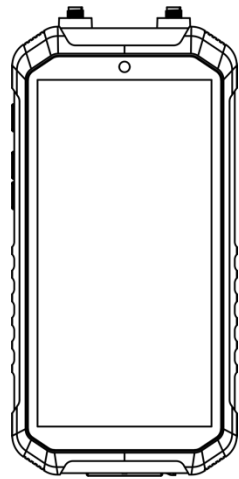
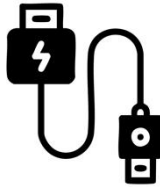
2.2 Delivery Checklist

Check the specifications and quantity of all parts and standard parts according to the equipment delivery list.

Part	Quantity	Description	Diagram
Main Unit	1	Used for radio signal reception, processing, and operation	
Type-C Cable	1	For device charging & data transfer	
Power Adapter	1	18W USB fast-charging adapter	
Wrist Strap	1	Attaches to the wristband mount of the device for portable wearing	
Foldable Receiving Antenna	4	SMA-connector rubber duck antenna	
Fiberglass Receiving Antenna	4	Fiberglass rod antenna	

3 Deploy the Equipment

3.1 Connect Antennas

1. Connect the two radio signal receiving antennas to the corresponding ports on the main unit by turning them clockwise, and tighten securely.

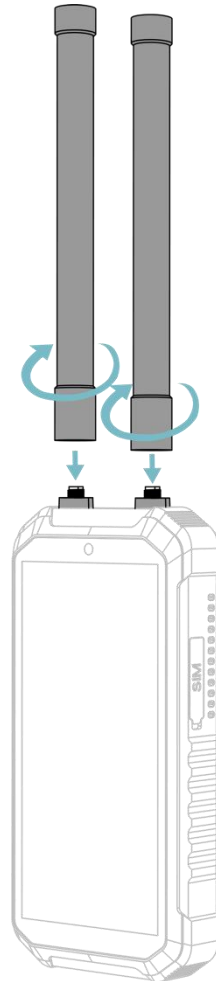

Only use the antennas supplied by the manufacturer and connect them to the SMA ports on the main unit; otherwise, the device's detection performance may be compromised.

The Wi-Fi detection antenna and the full-band detection antenna share the same performance characteristics and connector style, so no distinction is necessary. Attach each one to its corresponding port and tighten securely.

3.2 Power On / Power Off

1. After connecting the antennas, press and hold the power button for 3 seconds until the startup screen appears. When the system interface loads, the device automatically enters detection mode.

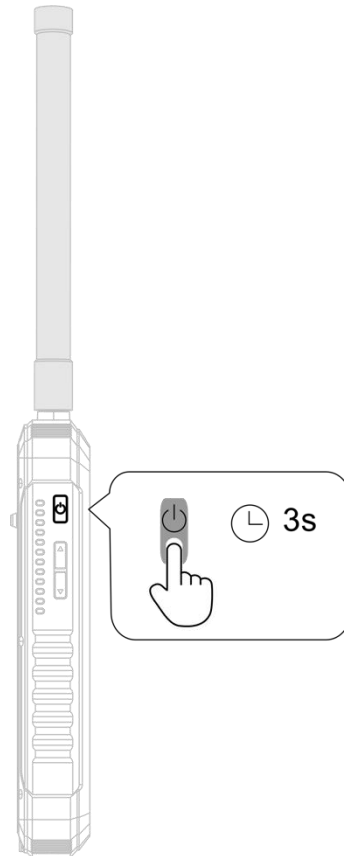

Briefly press the power button and select "Power Off" in the pop-up menu to shut down the device.

3.3 Connect to the Network

The device can connect to the network via Wi-Fi or by installing a 4G nano-SIM card. Once connected, it supports remotely viewing, accessing, and using online maps with the device.

Install the nano-SIM card:

1. Open the protective cover of the SIM card slot.

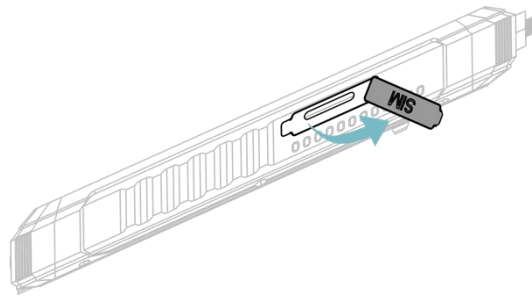

2. Insert the ejector pin into the small hole and push toward the device to eject the tray.

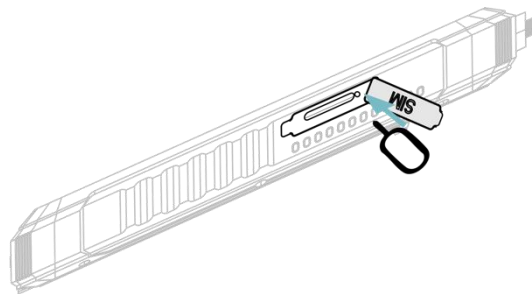

3. Pull the tray out of the slot.

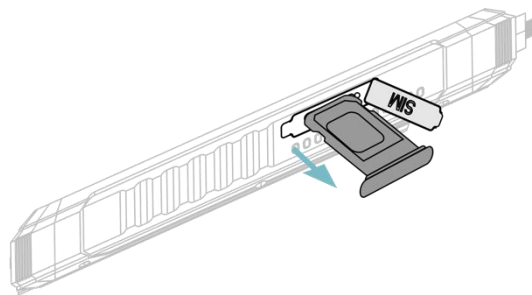

4. Insert the 4G nano-SIM card into the tray in the orientation as shown in figure below, ensuring the card lies flat after installation.

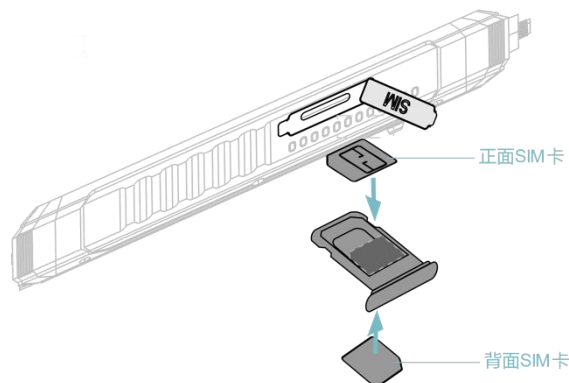

The device supports dual-SIM operation; SIM cards can be installed on either the front or the back of the tray.

5. Slide the tray horizontally into the slot, ensuring it is fully seated.

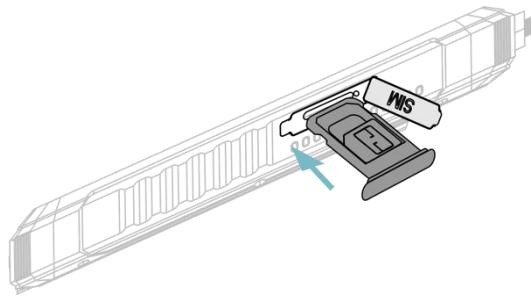

6. Close the protective cover.

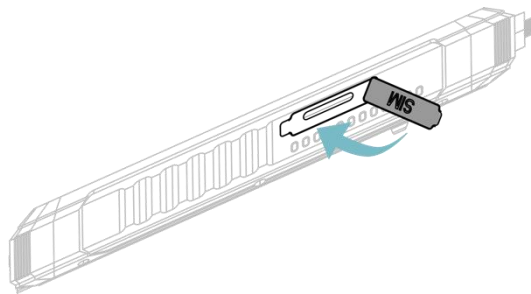

Connect WI-FI:

1. In the Bottom Function Area, select **Settings**, and select **System Network**.
2. Choose an existing configured Wi-Fi network or add a new one.

3.4 Install Micro SD Card

The device supports storage expansion and enhanced data transfer speeds through the installation of a Micro SD card.

1. Open the protective cover of the SIM card slot.
2. Insert the ejector pin into the small hole and push toward the device to eject the tray.
3. Pull the tray out of the slot.
4. Insert the Micro SD card into the tray in the orientation as shown in figure below, ensuring the card lies flat after installation.

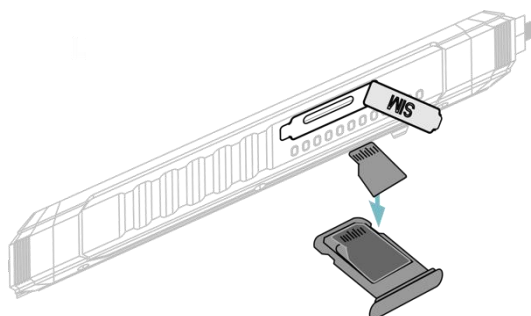



When installing a Micro SD card on the front side of the tray, the nano-SIM card can only be mounted on the back side of the tray if needed.

5. Slide the tray horizontally into the slot, ensuring it is fully seated.
6. Close the protective cover.

3.5 Charge

1. Open the Type-C port protective cover.
2. Connect the original power adapter and Type-C cable for charging. The device accepts DC input.

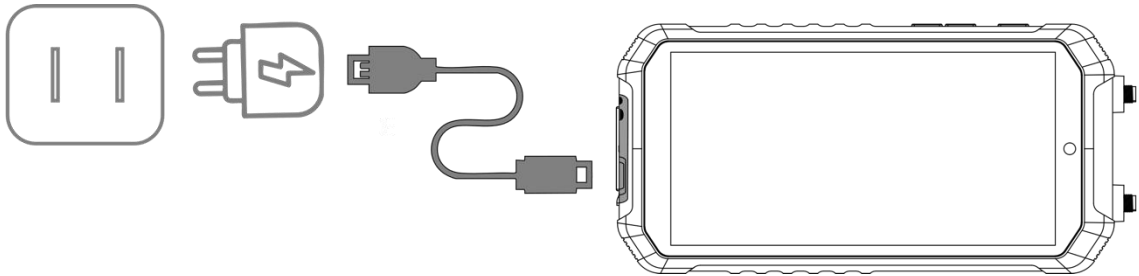

The main unit can only be charged with a USB Type-A to USB Type-C cable; use of the original adapter and cable is recommended.

4 Drone Defense System

After the device is turned on, the drone defense system starts automatically. The main interface is divided into an Information Display Area and a Bottom Function Area.



After entering the system, the status prompt box on the main interface will display a message to indicate that the sensor is starting up. The function controllers in the device then start up and search for GPS. This process takes approximately 20–30 seconds.

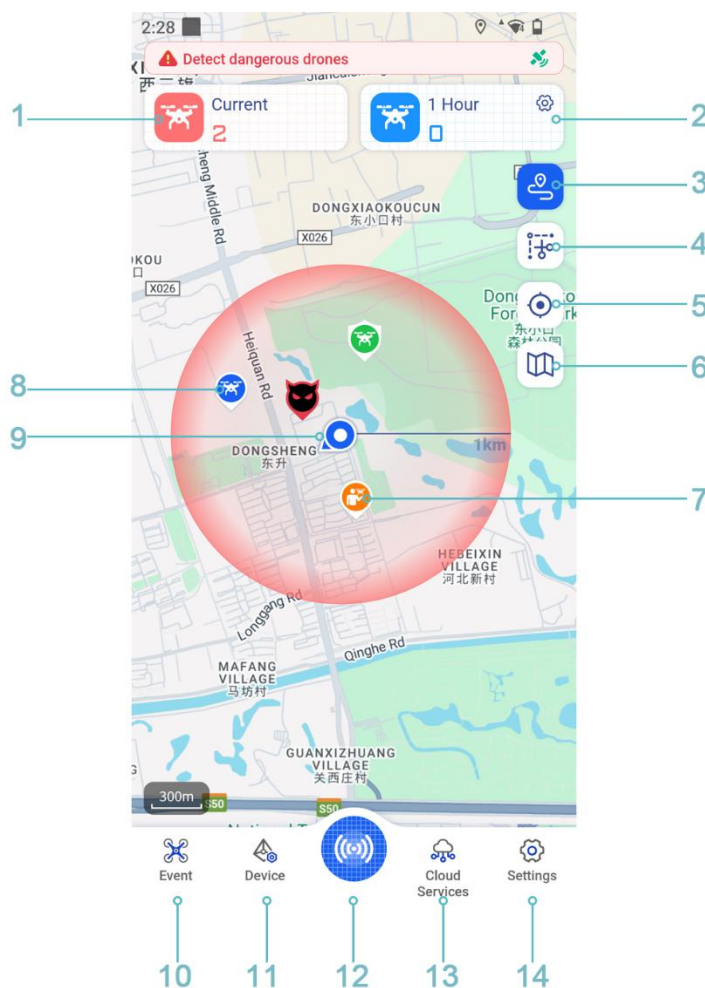

Information Display Area

- 1. Current Detection** Display the total number of drones currently being detected by the device
- 2. Historical Detection** Display the number of drones detected within a specified time frame. You can set multiple time ranges in the top right-hand corner.
- 3. Trajectory Display** Support switching operations for drone flight trajectories and pilot (remote control) trajectories. When the function button is in the on state, the trajectory can be viewed on the electronic map.
- 4. Hide Historical Trajectories** Hide the trajectories record that taken prior to the current time.
- 5. Center Position** Find the center of the device and display its protection area, with the center point at the center.
- 6. Map Layers** Switch between different types of map layer
- 7. Pilot Position** Display the current position of the pilot (remote controller)
- 8. Drone Position** Display the current position of the detected drone
- 9. Device Position** Display the current position of the device

Bottom Function Area

- 10. Events** Include detection logs, historical statistics, blacklist/whitelist settings, and current environment Wi-Fi signal detection
- 11. Device** View the real-time working status of the device's key modules and provide configuration options
- 12. Map** View the real-time positions of the detected drones and pilots (remote controller) on the map

13. Cloud Services

Access the command platform to view the status of multiple devices

14. Settings

Basic settings for the device and the map

4.1 Passive Detection

The system automatically raises an alarm when a drone is detected. The symbols and locations of the drones and their pilots (remote controllers) are displayed on the electronic map. Meanwhile, information about the detected drones is displayed in the information display area, including the details such as the brand, model, ID, flight frequency, direction of intrusion, reference distance, flight altitude and flight speed.

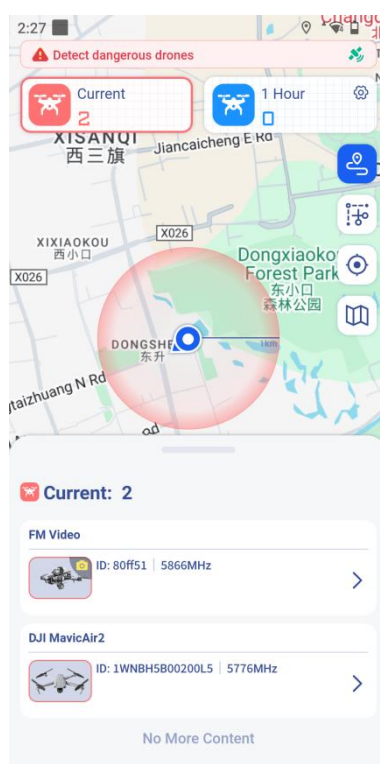

To view more detailed information, such as the drone's latitude and longitude, pilot information, and historical detection records, by expanding the drone information in the information display area.

Navigate Pilot Position

1. On the current drone detection interface, select the drone and

click  button on the right side to display the navigation information.

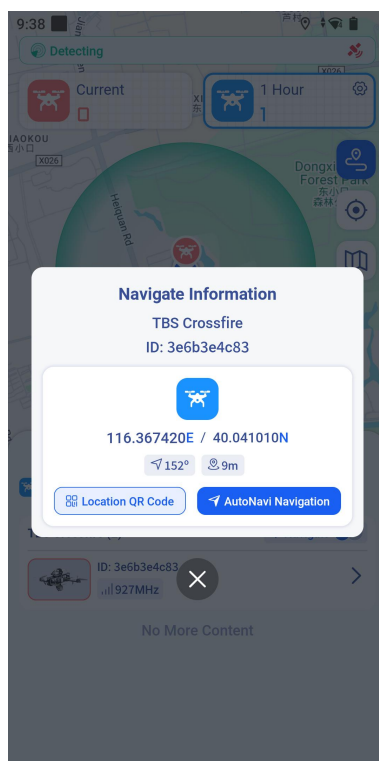

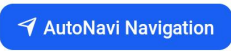
2. Click  button to view the real-time navigation of the pilot's position.

Add to Whitelist/Blacklist

1. On the current drone detection interface, select the drone and click  button on the right side.
2. According to the drone's status, click 'Add to Whitelist' or 'Add to Blacklist'.

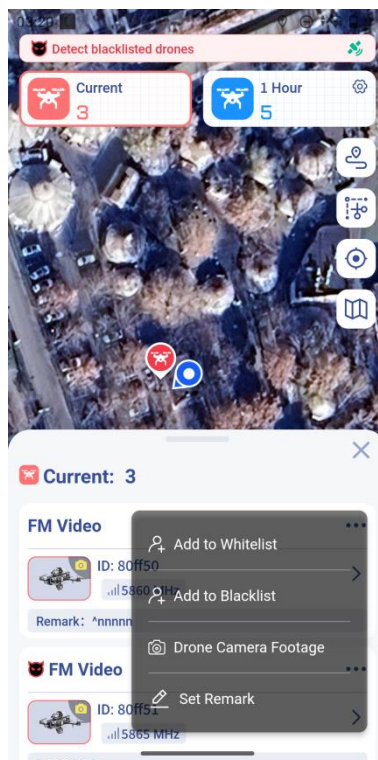

Show Drone Camera Footage

1. On the current drone detection interface, select the drone and click  button on the right side.
2. Click 'Drone Camera Footage' button, then the screenshot of the drone will be displayed. Click on the image to enlarge it.



4.2 Event Function Area

The Event Function Area contains five pages: Event, Statistics, Whitelist, Blacklist, and Wi-Fi Signal.

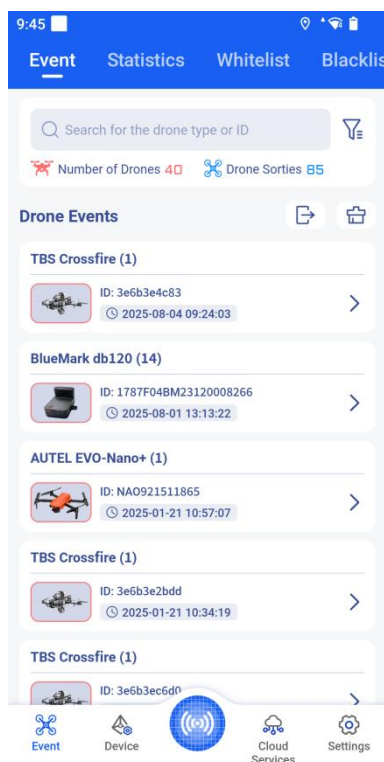

Check Event Page

1. Click on the 'Event' to enter the list of historical events.
2. Choose one drone event and click  button at the right side.
3. The drone's ID, detection time, duration, working frequency band, trajectory and other information can be viewed.



Check Statistics Page

1. Click on the 'Statistics' to enter the statistics interface.
2. You can view the statistics on drone events for the past 30 days, 3 months, or 1 year, which includes the number of events, duration, trends, drone flight time, common drone IDs, and common drone model.

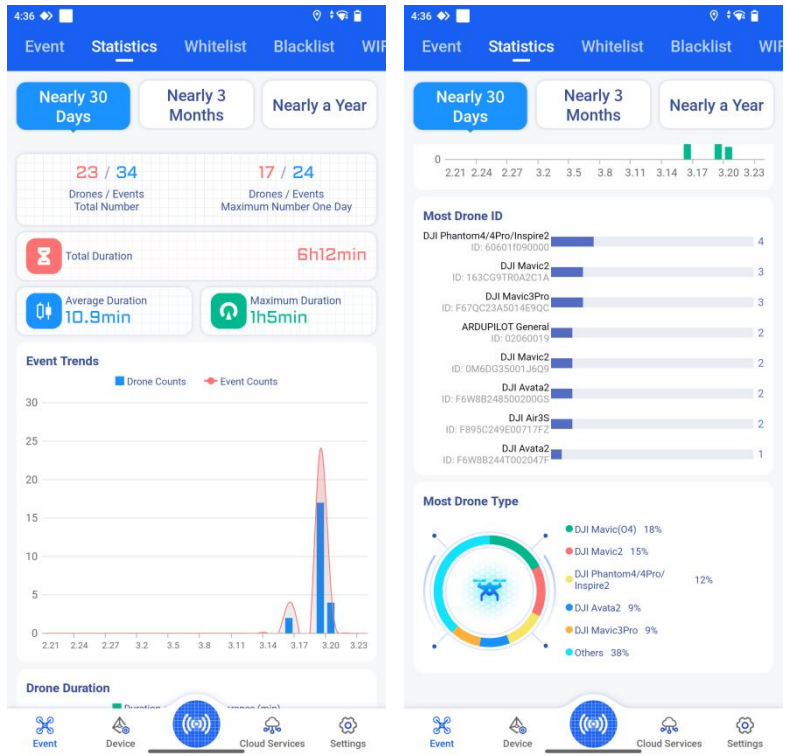

Edit Whitelist

1. Click on the 'Whitelist' to enter the whitelist interface.

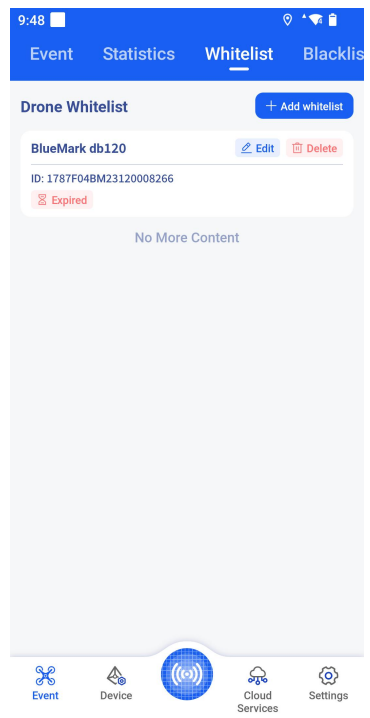

2. Choose the drone information that needs to be modified in the drone list and click  button.

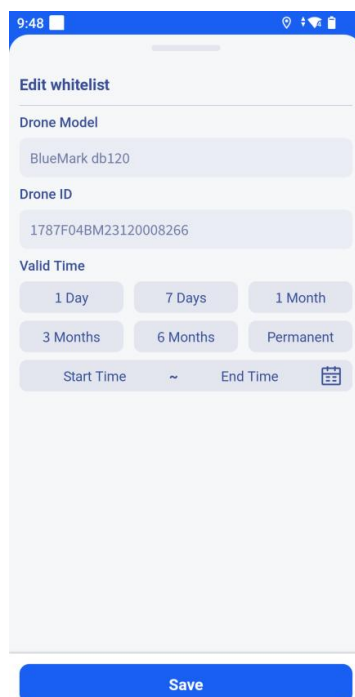

3. Enter the 'drone model', 'drone ID', and set the 'valid time' information, then click the 'Save' button.

Delete the Whitelist

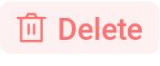
1. Click on the 'Whitelist' to enter the whitelist interface.
2. Choose the drone information to be deleted in the drone list and click  **Delete** button.

Add the Whitelist

Once the target drone has been added to the whitelist, the device will not raise the alarm when it detects the drone.

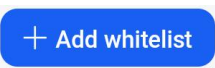
1. Click on the 'Whitelist' to enter the whitelist interface.
2. Click  button to enter the interface to add the whitelist.

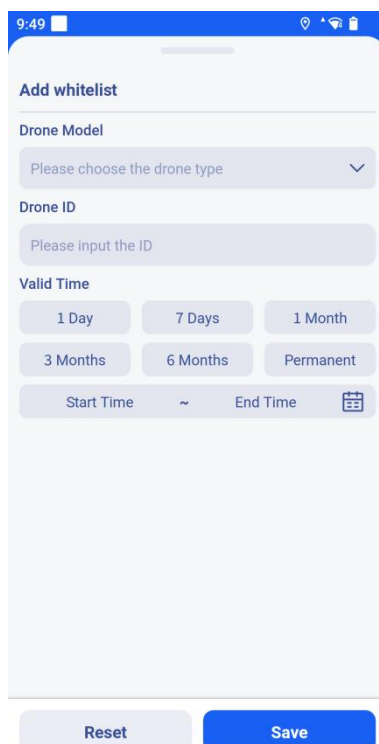



3. Enter the 'Drone Model', 'Drone ID', and set the 'Valid Time' information, then click the **'Save'** button.

Add the Blacklist

Once the target drone has been added to the blacklist, the device will raise the alarm when it detects the drone.

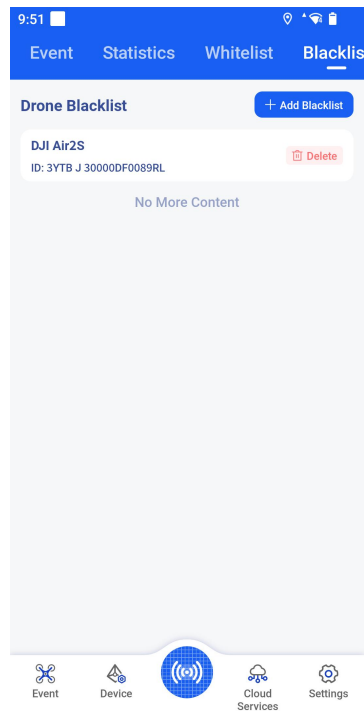
1. Click on the 'Blacklist' to enter the blacklist interface.



- Click  button to enter the interface to add the blacklist

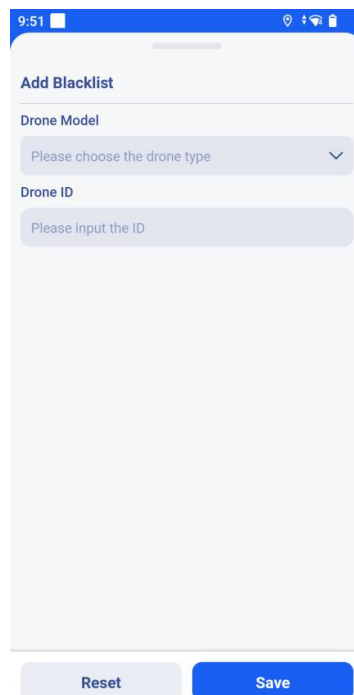

- Enter the 'Drone Model' and 'Drone ID', then click the '**Save**' button.

Delete the Blacklist

- Click on the 'Blacklist' to enter the blacklist interface.

2. Choose the drone information to be deleted in the drone list and click  **Delete** button.

Mark Dangerous Wi-Fi Drones

The Wi-Fi signal page primarily displays the detected Wi-Fi drone signals in the current environment. Users can mark the Wi-Fi signal.

1. Click on the 'Wi-Fi Signal' to enter the list.
2. Mark the Wi-Fi signal.
 - a) Users can select and mark the known non-Wi-Fi drones as 'Safe'. After marking, the system will not alarm when detecting this signal.
 - b) Users can select and mark the Wi-Fi drone as 'Danger'. After marking, the system will alarm when detecting this signal, as shown in **错误!未找到引用源。**

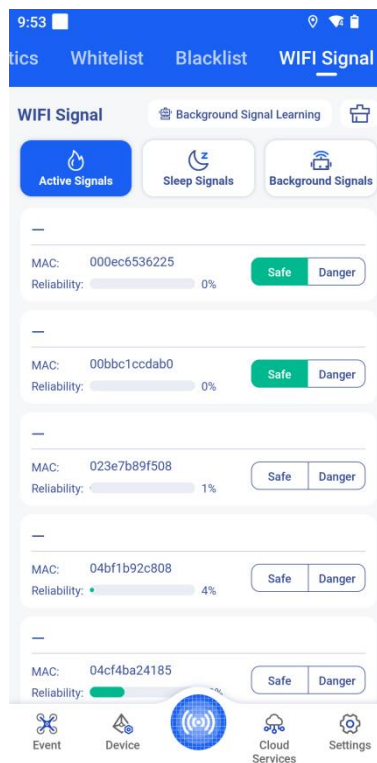

4.3 Device Status

The Device Status page allows users to view the status of the controller, engine and sensor, as well as make settings.

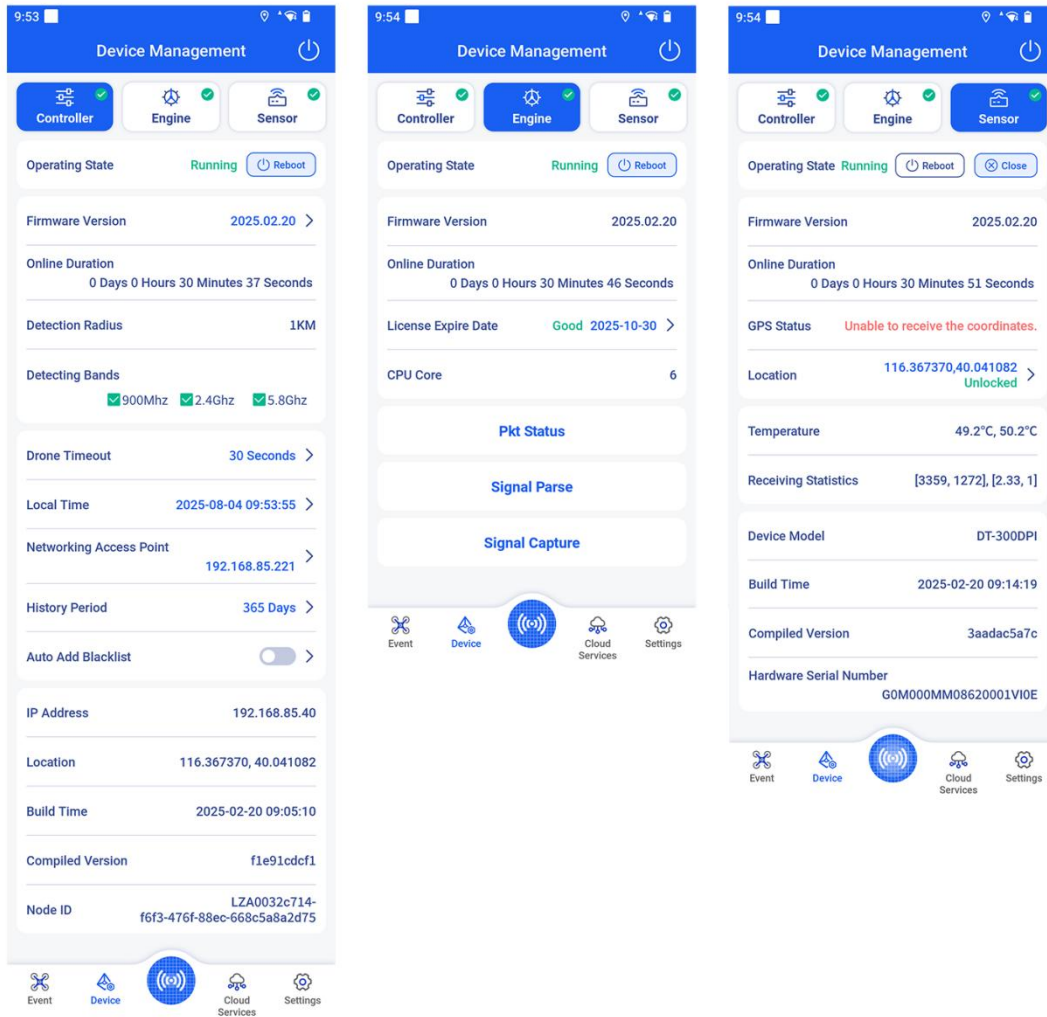

Reboot Controller

The controller needs to be restarted after it malfunctions or certain settings are made.



1. Click on the 'Controller' to enter the page.
2. Click  button on the 'Operating State' bar to reboot the controller.

Upgrade Firmware Version

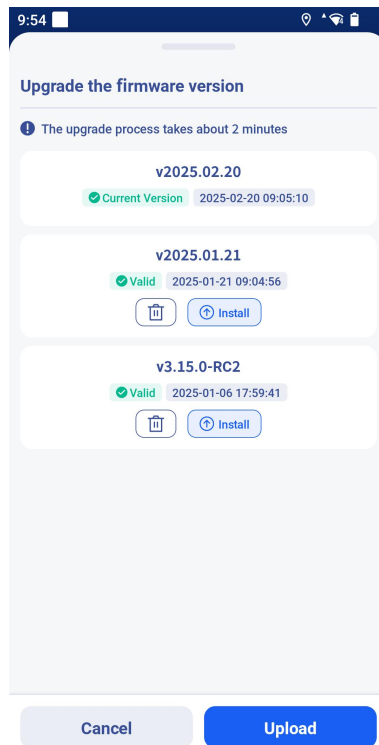
1. Click on the 'Controller' to enter the page.
2. Click  button at the right side on the 'Firmware Version' bar to enter the list.



3. Upgrade the firmware version.

- a) If the version to be upgraded is in the list, click  button to start installation.
- b) If the version to be upgraded is not in the list, click  button to add the firmware installation package into the list by downloading or uploading.

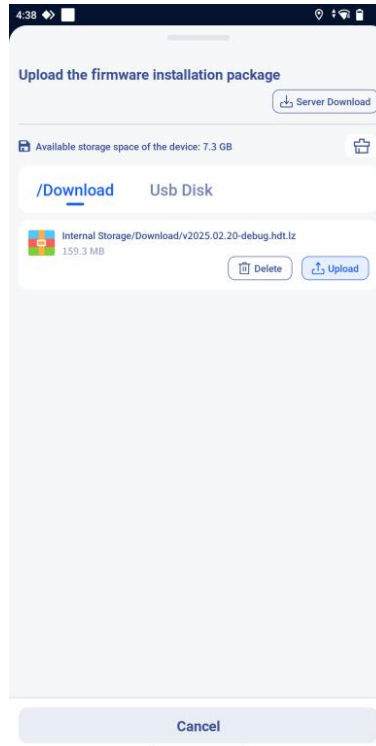



Set Detection Bands

1. Click on the 'Controller' to enter the page.
2. Select the detection frequency band on the bar.

Set Drone Timeout

When the detected drone signal disappears and exceeds the set drone timeout period, the device will not display the drone information.

1. Click on the 'Controller' to enter the page.
2. Click  button on the 'Drone Timeout' bar to modify the drone timeout period.
3. Click  button to reboot the controller and make the modification effective.

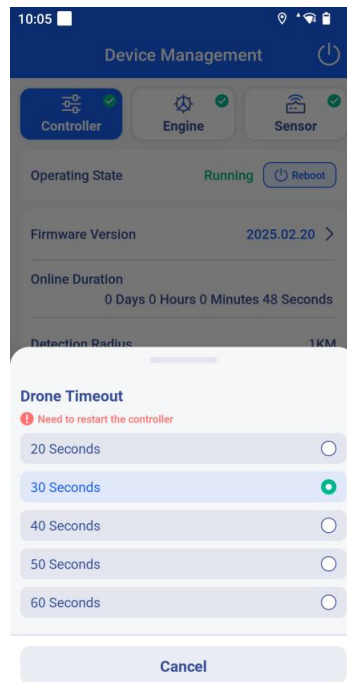

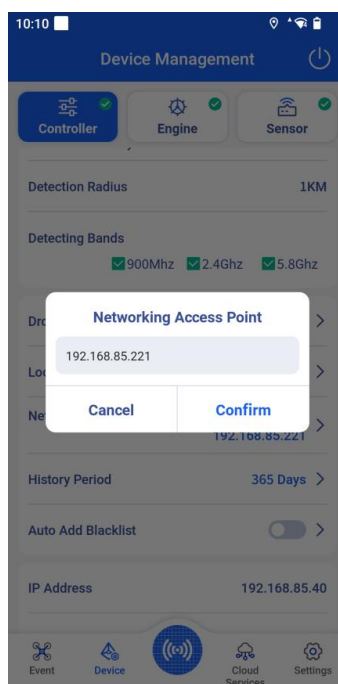

Set Networking Access Point

1. Click on the 'Controller' to enter the page.
2. Click > button on the 'Networking Access Point' bar to set the website address for the cloud services. This can be set to the CCS Command and Control platform address for networking purposes.



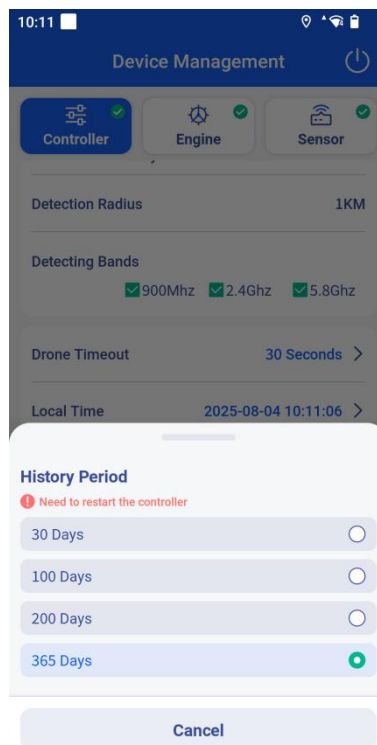

Set History Period

1. Click on the 'Controller' to enter the page.
2. Click  button on the 'History Period' bar to modify the device history retention period.
3. Click  button to reboot the controller and make the modification effective.



Enable Auto Add Blacklist

Once enabled, the function will automatically add any drones detected a specified number of times within a specified number of days to the blacklist.

1. Click on the 'Controller' to enter the page.
2. Click  button on the 'Auto Add Blacklist' bar.
3. Enable the auto add blacklist function by sliding the button, and set the time period and event count.
4. Click  button to reboot the controller and make the modification effective.

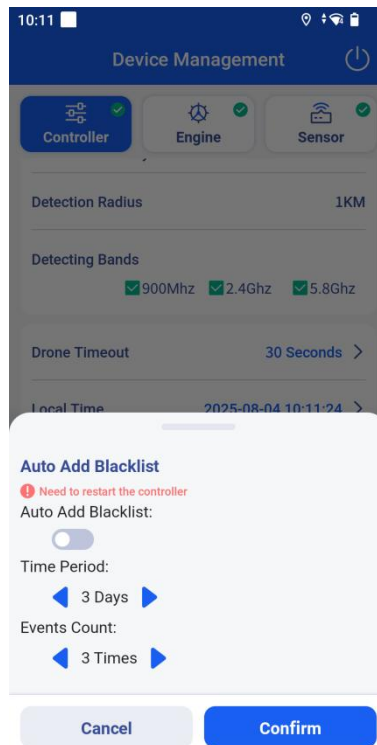

Reboot Engine

1. Click on the 'Engine' to enter the page.
2. Click  button on the 'Operating State' bar to reboot the engine.

Check License Expire Date

1. Click on the 'Engine' to enter the page.
2. Click  button on the 'License Expire Date' bar to check the device's valid authorization period.
 - a) Users can export ID, copy ID, and generate a QR code.
 - b) Users can contact us to obtain the authorization file, select to import the authorization file and verify it, and extend the authorization period.

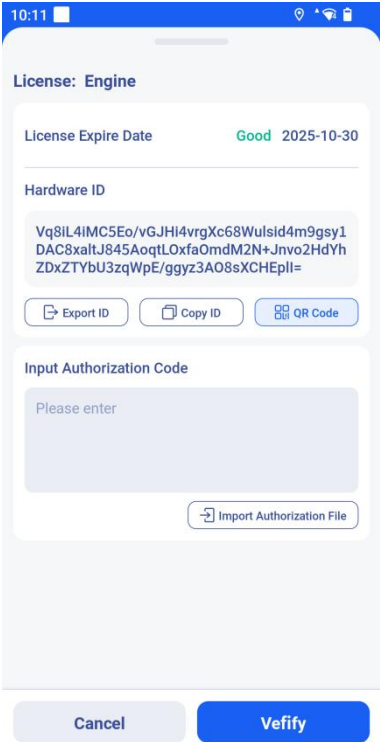

Check Pkt Status

- 1. Click on the 'Engine' to enter the page.
- 2. Click the 'Pkt Status' button to check the status of packages being received and sent.

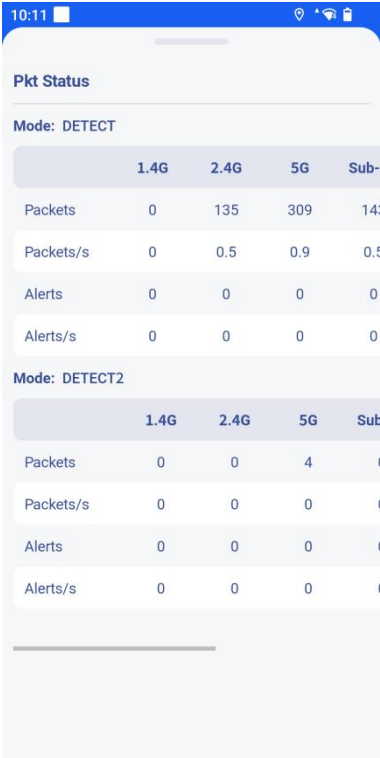

Signal Parse

1. Click on the 'Engine' to enter the page.
2. Click the 'Signal Parse' button to enter the interface.
3. Click  button to check the report.

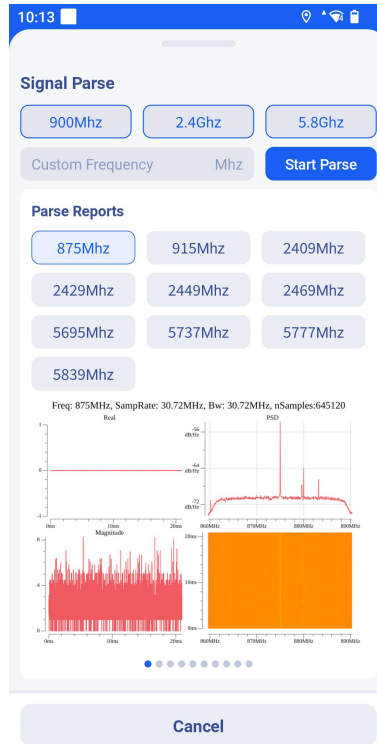

Signal Capture

1. Click on the 'Engine' to enter the page.
2. Click the 'Signal Capture' button to enter the interface.
3. Click  button to view the signal information.

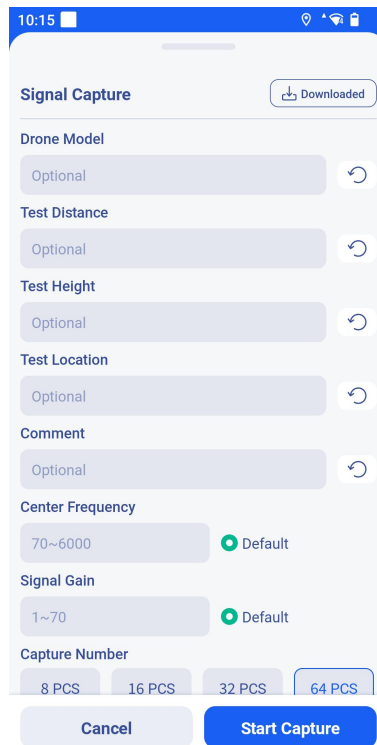

Reboot Sensor

1. Click on the 'Sensor' to enter the page.
2. Click  button on the 'Operating State' bar to reboot the sensor.

Close Sensor

1. Click on the 'Sensor' to enter the page.
2. Click  button on the 'Operating State' bar to close the sensor.

Set Location

1. Click on the 'Sensor' to enter the page.
2. Click  button on the 'Location' bar to manually set the GPS location and fix it to the current address.

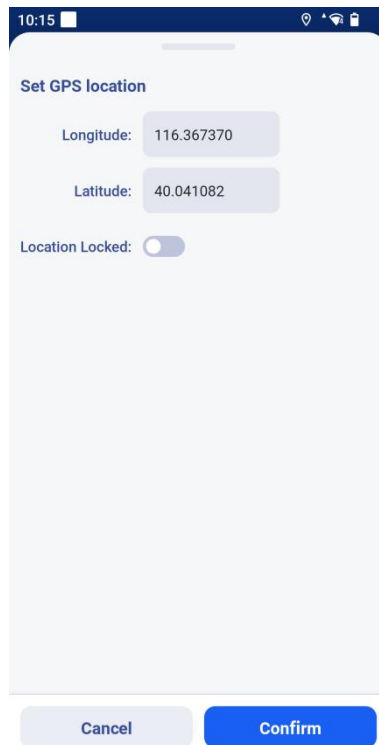

In normal conditions, the sensor can obtain and display the GPS address.

4.4 Cloud Services

The CCS Command and Control Platform can be accessed via the cloud service, where it can be used in coordination with other devices.

4.5 Settings

In the settings interface, users can configure the app and maps.

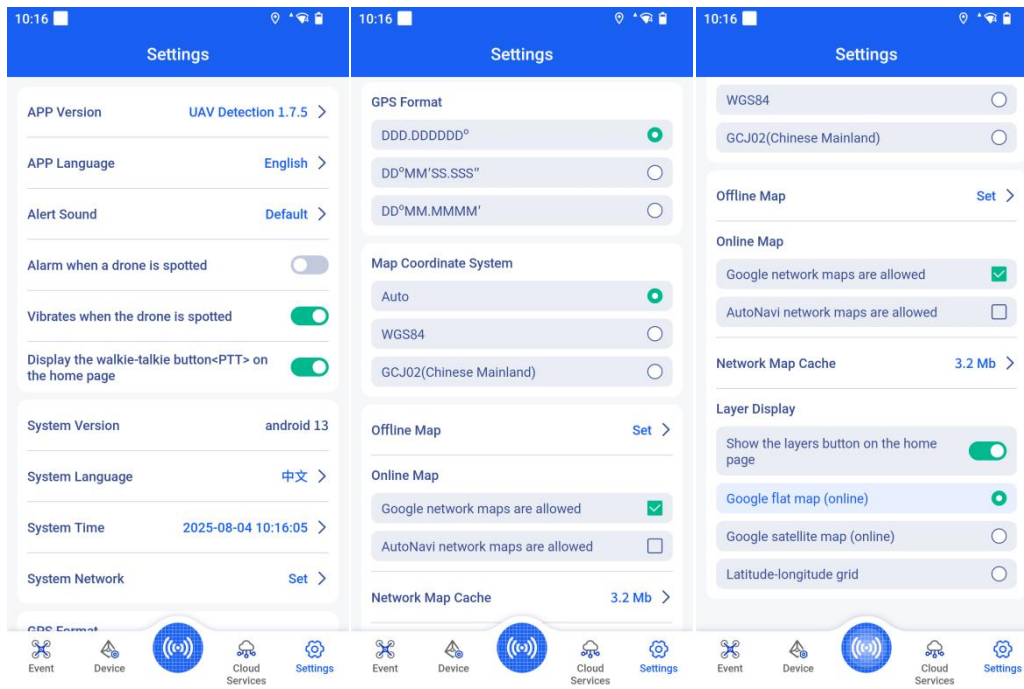

Upgrade APP Version

1. Click  button on the 'APP Version' bar to enter the interface.
2. Upgrade the app by downloading it from the server or via a USB disk.

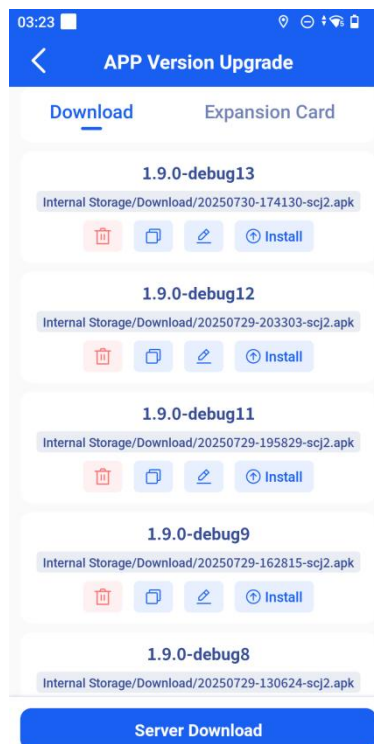

Set APP Language

1. Click > button on the 'APP Language' bar to enter the interface.
2. Change the display language of the app.

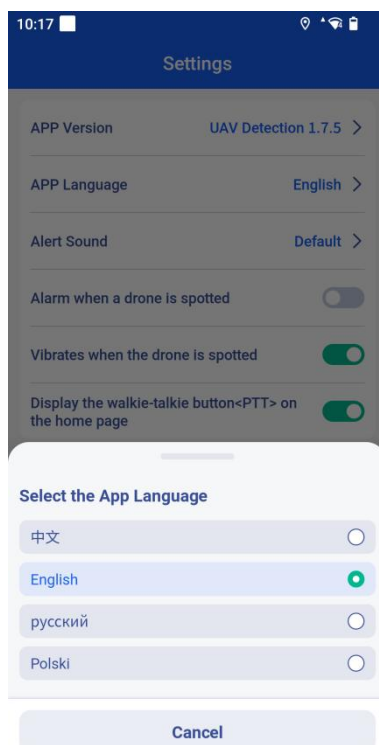

Set Alert Sound

1. Click > button on the 'Alert Sound' bar to enter the interface.
2. Select the ringtone to be used. Set it as the alarm sound.

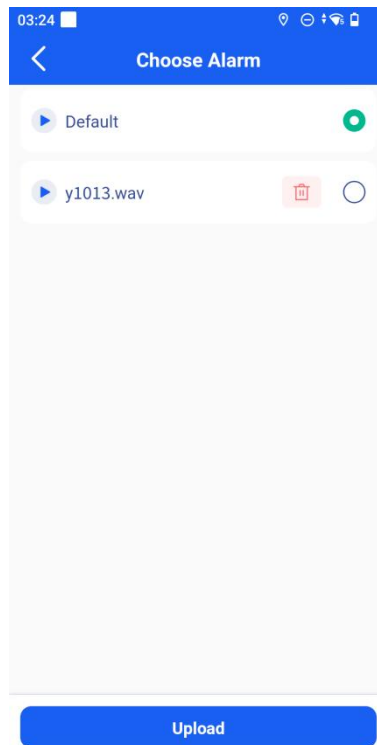

3. Click  button and upload the alert sound.



The ringtone upload supports .wav and .mp3 files.

Turn On/Off the Alarm

1. Slide the button to turn the alarm on or off on the 'Alarm when a drone is spotted' bar.

Map Settings

Switch Map Coordinate System

1. Switch the current map coordinate system.

Use Offline Map

1. Click the 'Set' button on the 'Offline Map' bar to enter the interface.



2. Install or use offline map.

Use Online Map

1. Once connected to the network, select whether to allow Google or Amap Network Maps to be used.

Clear Network Map Cache

1. Click  button on the 'Network Map Cache' bar to enter the interface.
2. Click 'Confirm' button to clear the online map cache.

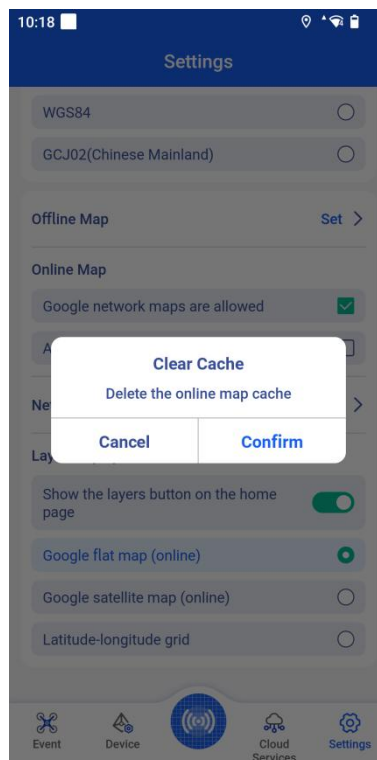

Switch GPS Format

1. Change the format of the GPS coordinates displayed on the home page.

Switch Map Layer

1. Select the map layer type.

5 Equipment Maintenance

To ensure stable operation of the equipment, please comply with the following maintenance specifications.

5.1 Routine Maintenance

Maintenance Type	Maintenance Method
Interface protection	Seal unused interfaces with protective covers.
Cable maintenance	<ul style="list-style-type: none"> Do not replace antennas without authorization after deployment. Ensure cables and interfaces are fully engaged and securely locked. Immediately replace any feeder/power/Ethernet cables with damaged jackets or exposed wires. Ensure plug pins are not bent or damaged.
Power inspection	Verify that the device is powered normally.

5.2 Basic Troubleshooting

Fault Type	Troubleshooting Method
Power-related fault	Power off the device, wait for 30 seconds, and then restart it.
Network disconnection	<ul style="list-style-type: none"> If using Wi-Fi connection, try reconnecting or switching to another available network. If using nano-SIM card for network connection, reinstall the SIM card and check the network status.
System Process Exception	Log in to the "Device" interface to check the process status of the controller, engine, and sensors.

If the issue persists, contact our technical support team.



Unauthorized personnel or non-designated maintenance personnel are prohibited from disassembling the chassis.

6 Packaging, Transportation and Storage

The equipment shall comply with the following requirements for packaging, transportation, and storage:

6.1 Packaging

The packing boxes shall be moisture-proof and shock-proof, and contain the following items:

- Delivery list
- Product Inspection Certificate
- User manual.

6.2 Transportation

In the process of transportation, avoid throwing, sun and rain, avoid mixing corrosive substances.

6.3 Storage

The storage shall meet the following requirements:

- Products should be stored in a cool, ventilated, dry warehouse.
- Do not put together with oil, away from heat sources.
- Stacking should be 20cm from the ground and 20cm from the wall.